



Date: \_\_\_\_\_ Type: \_\_\_\_\_

























Firm Name: \_\_\_\_\_

Project: \_\_\_\_\_

# iPlayer 3

Author, configure, and control dynamic LED light shows for DMX lighting networks

## ColorPlay 3 Effects

-  Fixed Color
-  Cross Fade
-  Color Wash
-  Chasing
-  Chasing Node
-  Sweep
-  Sweep Node
-  Sparkle
-  Streak
-  Spiral
-  Burst
-  Random Color
-  Image Fade
-  Video
-  Text
-  Strobe
-  Ripple
-  Particle
-  Colored Bars
-  Constant Modifier
-  Wave Modifier
-  Fade In Fade Out Modifier
-  RGB Range Modifier
-  Perlin Noise Modifier

iPlayer 3 controller is a compact yet powerful show storage and playback device capable of delivering light shows to installations with up to 340 unique light addresses. Packaged with ColorPlay 3 light show authoring software, iPlayer 3 is designed to add new levels of sophistication and flexibility to your lighting installations while eliminating the need for expensive lighting boards and technical programming expertise.

- Easy to use — With factory preset shows, custom show-authoring capabilities, an intuitive LCD interface, removable SD card storage, and onboard light addressing features, iPlayer 3 enables you to spend more time on the creative aspects of lighting design and less time on setup.
- Packaged with ColorPlay 3 light show authoring software — ColorPlay 3 gives you the flexibility to create and manage light shows using fully customizable effects, multi-track editing, timeline layering, and transition styles.
- Designed for use with the optional Controller Keypad — Controller Keypad is a wall-mounted user interface providing instant pushbutton playback of up to eight light shows.

- Supports the optional AuxBox expansion device — AuxBox automatically triggers up to eight iPlayer 3 light shows using any remote triggering device with a dry-contact closure. Via the AuxBox, you can trigger light shows by motion sensors, 3rd party control or sensor systems, and more.
- Control two DMX universes — iPlayer 3 has two DMX output ports, each controlling a universe of 512 DMX channels.
- Automate show playback — Set alarms to automatically trigger show playback based on a specific date, day of the week, weekdays, weekends, or an astronomical event, such as sunrise or sunset.

For detailed product information, please refer to the iPlayer 3 Product Guide at [www.philipscolorkinetics.com/ls/controllers/iplayer3/](http://www.philipscolorkinetics.com/ls/controllers/iplayer3/)

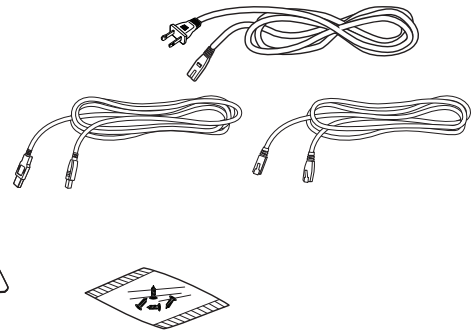
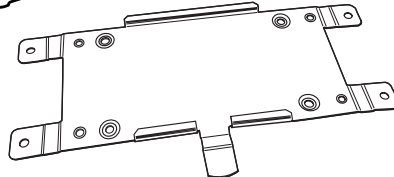
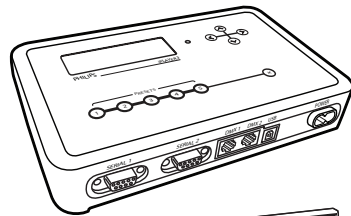

## Specifications

Due to continuous improvements and innovations, specifications may change without notice

Item	Specification	Details
Capability	Capacity	2 universes of 512 DMX addresses each
Electrical	Input Voltage	100 – 240 VAC, 50 / 60 Hz, 5 W
Control	Computer Interface	USB 2.0
	External / Auxiliary Interface	Two DMX512 RJ45 ports Two RS-232 9-pin serial ports
	Data Storage	Removable Secure Digital Card drive
Physical	Dimensions (Width x Depth x Height)	8.2 x 5.4 x 1.3 in (209 x 137 x 33 mm)
	Weight	1.2 lb (0.54 kg)
	Housing	Polycarbonate
	Operating Temperature	14° – 104° F (-10° – 40° C)
Certification and Safety	Certification	UL / cUL, FCC Class B, CE, CQC, C-Tick
	Environment	Dry Location, IP20

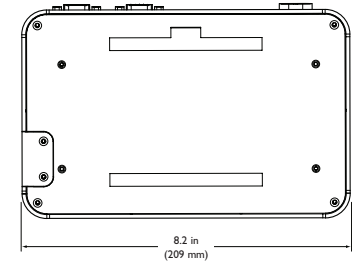
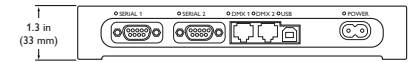
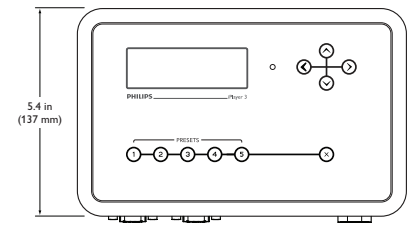

## Software Requirements

System Requirements	Specification	PC	Mac
Software	Operating System	Windows 2000 / XP / Vista	Mac OS 10.4 or greater
	Memory	512 MB RAM	512 MB RAM
	Disk space	60 MB free disk space	60 MB free disk space

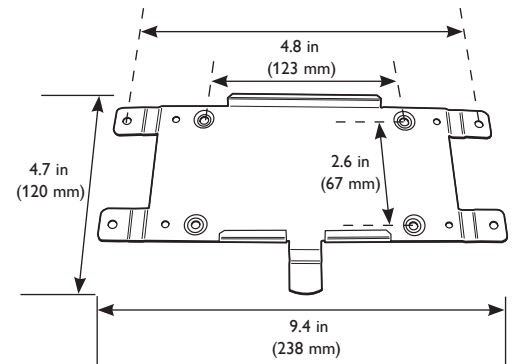

## iPlayer 3 and Accessories

Item	Type	Item Number	Philips 12NC
iPlayer 3	North America Power Cord	103-000019-00	910403327101
	Europe Power Cord	103-000019-01	910503700392
	China (CCC) Power Cord	103-000019-02	910503700738
Controller Keypad	DB-9 Serial	103-000020-00	910503700223
AuxBox	DB-9 Serial	103-000021-01	910503702433

Use Item Number when ordering in North America.

\* For detailed product information, please refer to the iPlayer 3 Product Guide at [www.philipscolorkinetics.com/ls/controllers/iplayer3/](http://www.philipscolorkinetics.com/ls/controllers/iplayer3/)

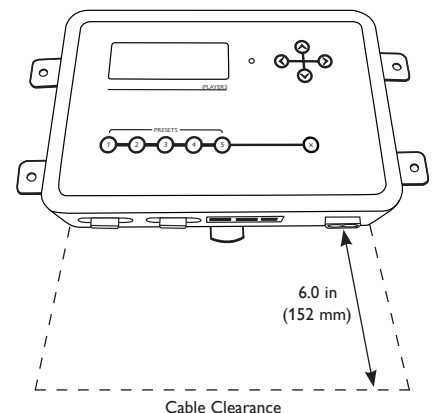

Copyright © 2015 Philips Solid-State Lighting Solutions, Inc. All rights reserved. Chromacore, Chromasic, CK, the CK logo, Color Kinetics, the Color Kinetics logo, ColorBlast, ColorBlaze, ColorBurst, ColorGraze, ColorPlay, ColorReach, iW Reach, eW Reach, DIMand, EssentialWhite, eW, iColor, iColor Cove, IntelliWhite, iV, iPlayer, Optibin, and Powercore are either registered trademarks or trademarks of Philips Solid-State Lighting Solutions, Inc. in the United States and / or other countries. All other brand or product names are trademarks or registered trademarks of their respective owners. Due to continuous improvements and innovations, specifications may change without notice. DAS-000020-01 R06 12 Aug 2015



Philips Color Kinetics  
3 Burlington Woods Drive  
Burlington, Massachusetts 01803 USA  
Tel 888.385.5742  
Tel 617.423.9999  
Fax 617.423.9998  
[www.philipscolorkinetics.com](http://www.philipscolorkinetics.com)