

Date: _____ Type: _____

Firm Name: _____

Project: _____

iColor Keypad

Compact wall-mounted lighting controller

iColor Keypad Effects

 **Fixed Color** — Displays a single color on all fixtures. iColor Keypad Up and Down buttons adjust effect brightness.

 **Variable Color** — Displays a single color on all fixtures. iColor Keypad Up and Down buttons adjust RGB value.

 **Color Wash** — Produces a smooth hue transition on all fixtures simultaneously, progressing through the color spectrum.

 **Rainbow Wash** — Produces a smooth hue transition through the color spectrum. Colors appear to follow each other from fixture to fixture.

 **Custom Wash** — Produces a smooth color transition on all fixtures simultaneously, progressing through two to six selected colors.

 **Random Color** — Displays a sequence of random colors on all fixtures, either fading or snapping from color to color.

 **RGB White** — Displays RGB white light on all fixtures, with user-specified color temperature. For color-changing LED fixtures.

 **Fixed White** — Displays white light on all fixtures, with user-specified color temperature. For two-channel intelligent white (iW) fixtures.

iColor Keypad is a compact stand-alone lighting controller for intelligent RGB and intelligent white LED lighting fixtures from Philips Color Kinetics. This Ethernet-based wall-mounted controller triggers up to eight light shows at the touch of a button. Power over Ethernet (PoE) technology eliminates the need for a separate power source, affording greater freedom of placement, higher reliability, and easy installation.

- Eight onboard effects and eight configurable scenes — iColor Keypad uses onboard lighting effects, eliminating the need for an external data source. Use the iColor Keypad Effect Manager configuration software to select from eight effects and adjust effect settings such as color, speed, and brightness as desired. Store up to eight sets of effects and settings as scenes. Recall scenes at the touch of a button.
- Power over Ethernet for increased flexibility — The IEEE 802.3af standard for Power over Ethernet (PoE) enables both electrical power and data to be transmitted over a single twisted-pair cable. Shared cabling reduces installation costs, decreases the space required for wires, and affords freedom of placement by eliminating wiring to a power source. iColor Keypad works with any PoE-compliant switch or PoE injector.
- Fingertip dimming and on / off control — Easily adjust brightness of connected lights from 0% – 100%, or turn them on and off.
- Simple installation with a single Ethernet connection — Mounts in a standard U.S. single-gang wall box. Uses a single CAT 5e or better cable for data and power with no additional wiring required.

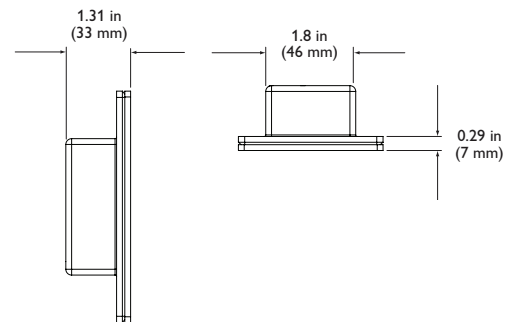
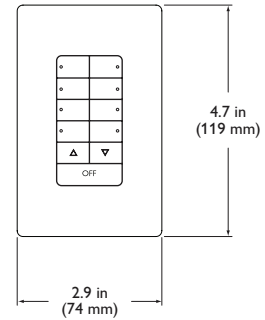

- Compact design with sleek Decora faceplate — Compact design uses wall space efficiently. Decora faceplate hides mounting hardware for a clean look that blends with a variety of architectural styles.

For detailed product information, refer to the iColor Keypad Product Guide at www.colorkinetics.com/lc/controllers/icolorkeypad/



Specifications

Due to continuous improvements and innovations, specifications may change without notice.

Item	Specification	Details
Control	Ethernet	Minimum 10BASE-T from any PoE- or IEEE 802.3af-compliant Ethernet switch. PoE injector required for use with non-IEEE 802.3af-compliant switches
Physical	Dimensions (Height x Width x Depth)	4.7 x 2.9 x 1.31 in (119 x 74 x 33 mm)
	Weight	4.23 oz (120 g)
	Housing	Medium matte white plastic Decora-style faceplate Mounts in single-gang wall box
	Connector / Cable	RJ45 Port, CAT 5e or better data cable (not included)
	Operating Temperature	14° – 104° F (-10° – 40° C)
Certification and Safety	Humidity	0 – 95%, non-condensing
	Certification	CSA, FCC Class B, CE
	Environment	Indoor rated, IP20



Included in the box

iColor Keypad
Software CD
Standard single-gang wall box for use outside of North America
(2) self-threading flat head countersunk M2.5 screws
Decora-style faceplate
Installation Instructions

iColor Keypad and Accessories

Item		Item Number	Philips 12NC
iColor Keypad		103-000028-00	910503702320
Power over Ethernet Switch	4 Power over Ethernet ports, 8 ports total	120-000084-01	910503702557
Power over Ethernet Injector	North America Power Cord	109-000029-00	910503700383
	Europe Power Cord	109-000029-01	910503700384



iColor Keypad buttons, showing factory settings

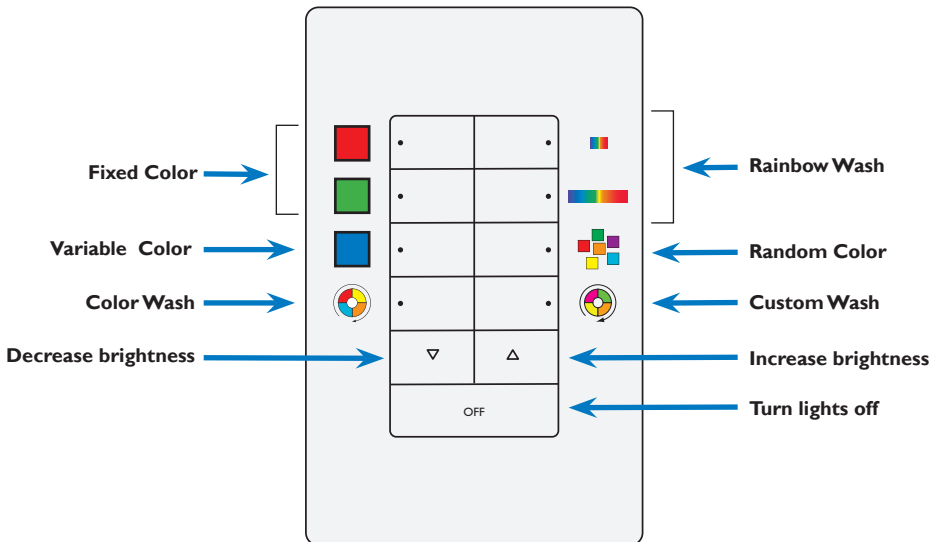

Philips Color Kinetics
 3 Burlington Woods Drive
 Burlington, Massachusetts 01803 USA
 Tel 888.385.5742
 Tel 617.423.9999
 Fax 617.423.9998
www.philipscolorkinetics.com

Copyright © 2011 Philips Solid-State Lighting Solutions, Inc. All rights reserved.
 Chromacore, Chromasic, CK, the CK logo, Color Kinetics, the Color Kinetics logo, ColorBlast, ColorBlaze, ColorBurst, eW Fuse, ColorGraze, ColorPlay, ColorReach, iW Reach, eW Reach, DIMand, EssentialWhite, eW, iColor, iColor Cove, IntelliWhite, iW, iPlayer, Optibin, and Powercore are either registered trademarks or trademarks of Philips Solid-State Lighting Solutions, Inc. in the United States and / or other countries. All other brand or product names are trademarks or registered trademarks of their respective owners. Due to continuous improvements and innovations, specifications may change without notice.

DAS-000085-01 R01 11-11